

Product Family	Arden
Adjustability	Adjustable: 350° - 90°
Color	White- Black- Gray- RAL
Mounting Type	Track
Body	Extruded aluminium body with electrostatic powder coated
Light Source	HP LED
Color Temperature	2700-3000-4000-5000-6500K
Color Rendering Index	CRI>80
Power	7,5 W
Power Factor	Pf>90
Luminaire Efficiency	120lm/W
Light Beam Angle	12°,36°,48°,10x35° Elptc.
Lumen	900 lm
Operating Voltage	220-240V AC / 50-60 Hz
Light Source Lifetime	50.000 hours Led lifetime
Optic	High efficiency optic in metallized thermoplastic and built into the innovative anti-glare screen
Control Type	On/Off- Dali
Electrical Insulation Class	Class I
Optional Features	Unavailable
Sealing	IP20
Weight	0,75 Kg
Dimensions	71 x 162 x 34 mm

DIMENSIONS

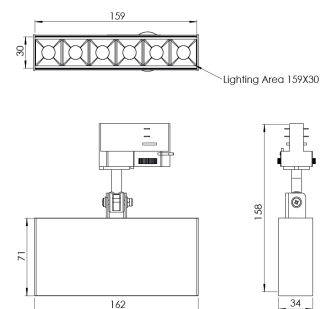

Lumen value is given according to 3000K value.

Luminaire is F-marked and suitable for direct mounting on normally flammable surfaces.

All components are provided with 5 year limited guarantee. A qualified electrician must ensure proper installation of the product.