

Product Family	Kendo
Adjustability	Adjustable: 350° - 90° + 15° & 15°
Color	White- Black- Gray- RAL
Mounting Type	Surface Mounted
Body	Extruded aluminium body with electrostatic powder coated

Light Source	HP LED/ COB LED
Color Temperature	2700-3000-4000-5000-6500K
Color Rendering Index	CRI>80 CRI>90
Power	38 W
Power Factor	Pf>90
Luminaire Efficiency	105.5 lm/W - 96.5 lm/W
Light Beam Angle	10°,25°,40°,60°
Lumen	3674 lm
Operating Voltage	220-240V AC / 50-60 Hz
Light Source Lifetime	50.000 hours Led lifetime
Optic	High efficiency acrylic lens

Control Type	On/Off- Dali
Electrical Insulation Class	Class I
Optional Features	Emergency kit system can be integrated
Sealing	IP20
Weight	5.2 kg
Dimensions	65x85xL1500 mm

DIMENSIONS

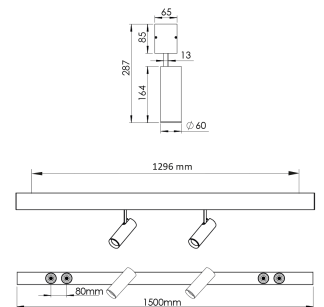

Lumen value is given according to 4000K value.

Luminaire is F-marked and suitable for direct mounting on normally flammable surfaces.

All components are provided with 5 year limited guarantee. A qualified electrician must ensure proper installation of the product.