



Product Family	Lorne
Adjustability	Adjustable: 350° - 90°
Color	White- Black- Gray- RAL
Mounting Type	Track
Body	Die-cast aluminium body with electrostatic powder coated

Light Source	COB LED
Color Temperature	Enhanced whiteness and vividness by diminishing of yellowish
Color Rendering Index	CRI>90
Power	28 W
Power Factor	Pf>90
Luminaire Efficiency	81 lm/W
Light Beam Angle	15°,24°,40°,60°
Lumen	2268 lm
Operating Voltage	220-240V AC / 50-60 Hz
Light Source Lifetime	50.000 hours Led lifetime
Optic	High efficiency reflector and PC glass

Control Type	On/Off- Dali
Electrical Insulation Class	Class II
Optional Features	Unavailable

Sealing	IP40
Weight	1,2 Kg
Dimensions	Ø100 x 117 mm

DIMENSIONS

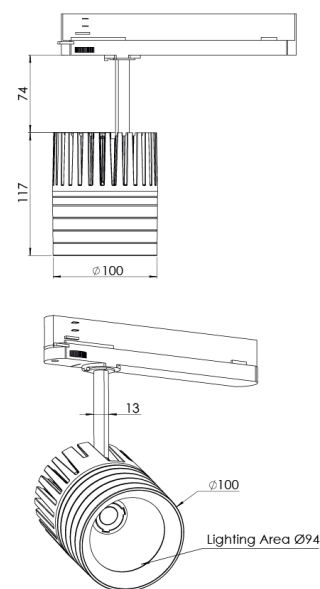

Lumen value is given according to 2700K value.

Luminaire is F-marked and suitable for direct mounting on normally flammable surfaces.

All components are provided with 5 year limited guarantee. A qualified electrician must ensure proper installation of the product.