



<b>Product Family</b>	Lorne
<b>Adjustability</b>	Adjustable: 350° - 90°
<b>Color</b>	White- Black- Gray- RAL
<b>Mounting Type</b>	Track
<b>Body</b>	Die-cast aluminium body with electrostatic powder coated

<b>Light Source</b>	COB LED
<b>Color Temperature</b>	VIVID WHITE, GREEN AND RED
<b>Color Rendering Index</b>	CRI>80
<b>Power</b>	35 W
<b>Power Factor</b>	Pf>90
<b>Luminaire Efficiency</b>	85 lm/W
<b>Light Beam Angle</b>	15°,24°,40°,60°
<b>Lumen</b>	2975 lm
<b>Operating Voltage</b>	220-240V AC / 50-60 Hz
<b>Light Source Lifetime</b>	50.000 hours Led lifetime
<b>Optic</b>	High efficiency reflector and PC glass

<b>Control Type</b>	On/Off- Dali
<b>Electrical Insulation Class</b>	Class II
<b>Optional Features</b>	Unavailable

<b>Sealing</b>	IP40
<b>Weight</b>	1,2 Kg
<b>Dimensions</b>	Ø100 x 117 mm

## DIMENSIONS

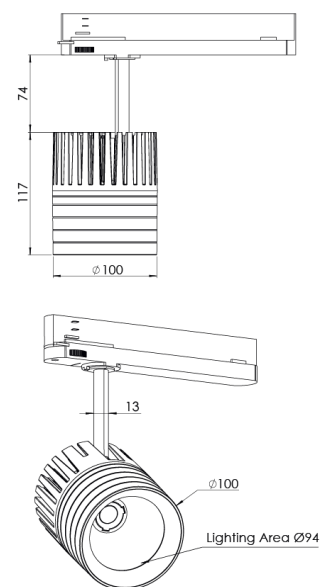

Luminaire is F-marked and suitable for direct mounting on normally flammable surfaces.  
All components are provided with 5 year limited guarantee. A qualified electrician must ensure proper installation of the product.