

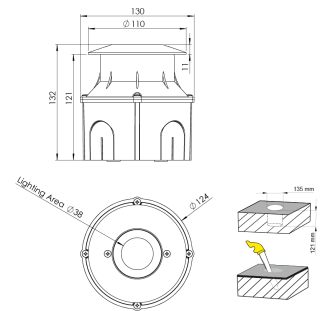

<b>Product Family</b>	Mirae
<b>Adjustability</b>	Fixed
<b>Color</b>	White- Black- Gray- RAL
<b>Mounting Type</b>	
<b>Body</b>	Electrostatic powder coated aluminum body, Plastic injection case
<b>Light Source</b>	HP LED
<b>Color Temperature</b>	2700-3000-4000-5000-6500K
<b>Color Rendering Index</b>	CRI>80
<b>Power</b>	5 W
<b>Power Factor</b>	Pf>90
<b>Luminaire Efficiency</b>	57lm/W
<b>Light Beam Angle</b>	24°,36°
<b>Lumen</b>	285 lm
<b>Operating Voltage</b>	220-240V AC / 50-60 Hz
<b>Light Source Lifetime</b>	50.000 hours Led lifetime
<b>Optic</b>	High efficiency acrylic lens,Extra clear tempered glass
<b>Control Type</b>	On/Off
<b>Electrical Insulation Class</b>	Class I
<b>Optional Features</b>	Unavailable
<b>Sealing</b>	IP66
<b>Weight</b>	0,7 Kg
<b>Dimensions</b>	Ø110 x 132 mm

## DIMENSIONS



Lumen value is given according to 3000K value.

Luminaire is F-marked and suitable for direct mounting on normally flammable surfaces.

All components are provided with 5 year limited guarantee. A qualified electrician must ensure proper installation of the product.