

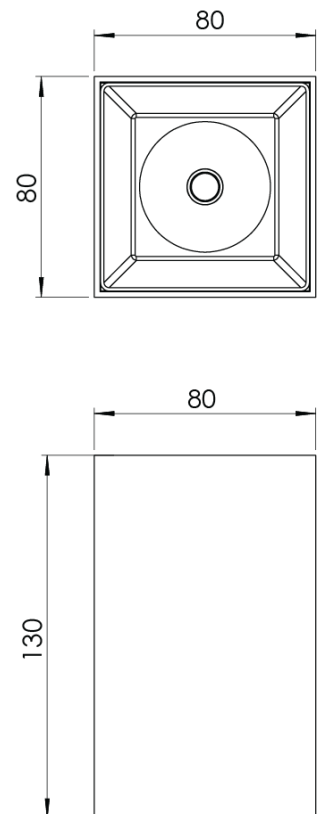

Product Family	Solde
Adjustability	Fixed
Color	White- Black- Gray- RAL
Mounting Type	Surface Mounted
Body	Electrostatic powder coated extruded aluminum body
Light Source	COB LED
Color Temperature	2700-3000-4000-5000-6500K
Color Rendering Index	CRI>80,CRI>90
Power	9 W
Power Factor	Pf>90
Luminaire Efficiency	103lm/W
Light Beam Angle	15°,24°,36°,60°
Lumen	927 lm
Operating Voltage	220-240V AC / 50-60 Hz
Light Source Lifetime	50.000 hours Led lifetime
Optic	High efficiency reflector and PC glass
Control Type	On/Off
Electrical Insulation Class	Class I
Optional Features	
Sealing	IP20
Weight	0,6 Kg
Dimensions	80x80x130mm

DIMENSIONS



Lumen value is given according to 4000K value.

Luminaire is F-marked and suitable for direct mounting on normally flammable surfaces.

All components are provided with 5 year limited guarantee. A qualified electrician must ensure proper installation of the product.