

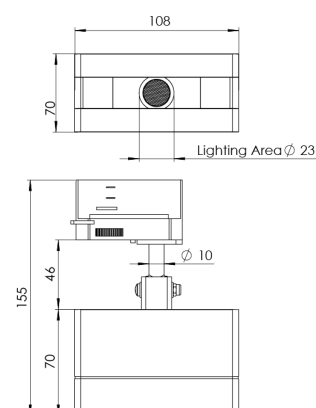

<b>Product Family</b>	Sova
<b>Adjustability</b>	Adjustable: 350° - 90°
<b>Color</b>	White- Black- Gray- RAL
<b>Mounting Type</b>	Track
<b>Body</b>	Extruded aluminium body with electrostatic powder coated, Injection cover
<b>Light Source</b>	HP LED
<b>Color Temperature</b>	2700-3000-4000-5000-6500K
<b>Color Rendering Index</b>	CRI>80
<b>Power</b>	2,2 W
<b>Power Factor</b>	Pf>90
<b>Luminaire Efficiency</b>	92lm/W
<b>Light Beam Angle</b>	10°,25°,40°,60°
<b>Lumen</b>	203 lm
<b>Operating Voltage</b>	220-240V AC / 50-60 Hz
<b>Light Source Lifetime</b>	50.000 hours Led lifetime
<b>Optic</b>	High efficiency acrylic lens
<b>Control Type</b>	On/Off
<b>Electrical Insulation Class</b>	Class I
<b>Optional Features</b>	Unavailable
<b>Sealing</b>	IP20
<b>Weight</b>	0,5 Kg
<b>Dimensions</b>	51,7 x 155 x 108 mm

## DIMENSIONS



Lumen value is given according to 2700K value.

Luminaire is F-marked and suitable for direct mounting on normally flammable surfaces.

All components are provided with 5 year limited guarantee. A qualified electrician must ensure proper installation of the product.