



Product Family	Tella
Adjustability	Fixed
Color	White- Black- Gray- RAL
Mounting Type	Pendant
Body	Extruded aluminium body with electrostatic powder coated

Light Source	MP LED
Color Temperature	2700-3000-4000-5000-6500K
Color Rendering Index	CRI>80,CRI>90
Power	40 W
Power Factor	Pf>90
Luminaire Efficiency	45lm/W
Light Beam Angle	
Lumen	1772 lm
Operating Voltage	220-240V AC / 50-60 Hz
Light Source Lifetime	50.000 hours Led lifetime
Optic	High efficiency Silicone opal diffusers

Control Type	On/Off- Dali
Electrical Insulation Class	Class II
Optional Features	Unavailable

Sealing	IP20
Weight	1,1 Kg
Dimensions	Ø900 x 40 mm

DIMENSIONS

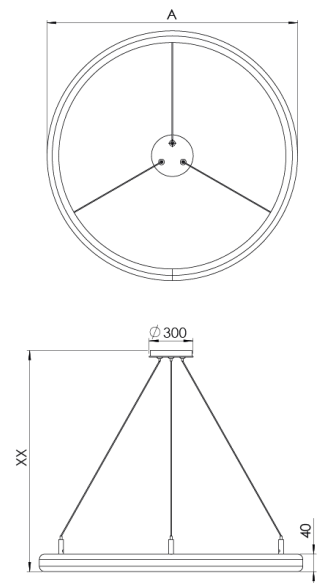

Lumen value is given according to 4000K value.

Luminaire is F-marked and suitable for direct mounting on normally flammable surfaces.

All components are provided with 5 year limited guarantee. A qualified electrician must ensure proper installation of the product.